











## PARTI PER DURKOPP

Cl. 171, 173, 742, 743, 744



						
<b>ER106C D04602</b> 0171 004602	<b>ER106C D03725</b> 0173 003725	<b>ER106C D01027</b> 0195 001027	<b>ER106C D05712</b> 0933 005712	<b>ER106C D04017</b> 0196 104017	<b>ER106C D17104</b> 0939 017104	<b>ER106C D17504</b> 0939 017504



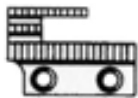
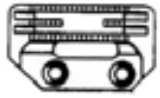
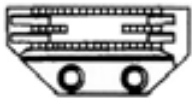
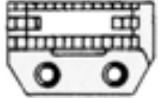

### Cl. 211

				
<b>ER104C000027</b> 0211 000261 HDU-211	<b>ER104C000180</b> 0211 000275 Normale <b>ER104C000181</b> 0211 000275 Frizionata	<b>ER104C000026</b> 0211 000912 rasafilo HDU-211(1)	<b>ER104C000220</b> 0211 010772 NBL Frizionata	<b>ER104C000352</b> 0204 000230 ferro <b>ER104C000353</b> 0204 000230A Allum.





			
<b>ER110C000219</b> 0204 000243	<b>ER110C000221</b> 0204 000235	<b>ER110C000223</b> 0211 004521	<b>ER110C000225</b> 0211 001491

			
<b>ER110C000220</b> 0204 000268	<b>ER110C000222</b> 0204 000260 / 002291	<b>ER110C000224</b> 0211 004522 / 000758	<b>ER110C000226</b> 0211 001492













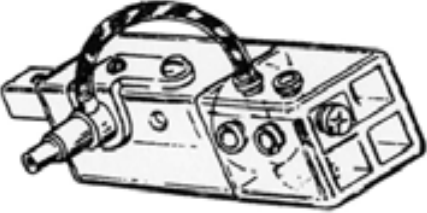

		
<b>ER110C000227</b> 0211 009795	<b>ER110C000229</b> 0211 009823 / 0211 050504 Pesante	<b>ER110CDP2110</b> Placca per bordatori

			
<b>ER110C000228</b> 0211 050511 / 009794	<b>ER110C000230</b> 0211 050505 / 009796	<b>ER110C000231</b> 0211 009824 Pesante	<b>ER110CDG2110</b> Griffa per bordatori



Cl. 211

 <p><b>ER110CD11339</b> 0211 000339 Barra ago</p>		 <p><b>ER110CD22437</b> 0212 000437 Barra piedino</p>			
 <p><b>ER110CD19000</b> 0211 009000 Guidafilo</p>	 <p><b>ER110CD11462</b> 0211 000462</p>	 <p><b>ER110CD11376</b> 0211 000376</p>	 <p><b>ER110CD11146</b> 0211 000146 Kit</p>		
 <p><b>ER110CD13041</b> N900 023421 Guida</p>	 <p><b>ER106C000087</b> 0219 006708 A Coltello</p>	 <p><b>ER106C000088</b> 0211 009685 Coltello Fisso Scorr.</p>	 <p><b>ER106C000089</b> 0211 050366 Coltello</p>	 <p><b>ER110CD10213</b> 0211 050213 Leva</p>	
 <p><b>ER110CD11473</b> 0211 000473 Bussola</p>	 <p><b>ER110CD10212</b> 0211 050212 Perno</p>	 <p><b>ER110CD11476</b> 0211 000476 Perno</p>	 <p><b>ER110CD10216</b> 0211 050216 Molla tensione</p>	 <p><b>ER110CD10214</b> 0211 050214 Piattello</p>	 <p><b>ER110CD10479</b> 0004 000079 Molla</p>
 <p><b>ER110CD14202</b> 0114 000202</p>	 <p><b>ER110CD11482</b> 0211 000482 Dado</p>	 <p><b>ER110CD10215</b> 0211 050215 Bussola</p>	 <p><b>ER110CD11471</b> 0211 000471 Perno</p>	 <p><b>ER110CD04235</b> 0204 000235 Molla tensione</p>	 <p><b>ER110CD14136</b> 0204 000136 piattello</p>
 <p><b>ER110CD11381</b> 0211000381</p>	 <p><b>ER110CD16591</b> 0216 000591 Gommino</p>	 <p><b>ER110CD19830</b> 0211 009830</p>	 <p><b>ER110CD13112</b> 1001 003112</p>	 <p><b>ER110CD11938</b> 0211 000938</p>	 <p><b>ER110CD19649</b> 0211 009649</p>





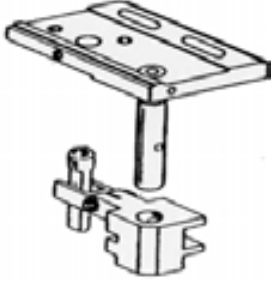





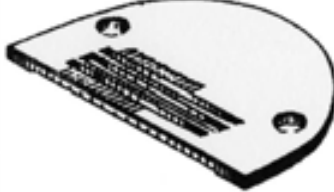

Cl. 211

 <p>ER110CD11491 0211 000491 Guidafilo</p>	 <p>ER110CD11564 0211 000564 leva avanti/indietro</p>	 <p>ER110CD11514 0211 000514 Albero filarello cpl.</p>	 <p>ER110CD13122 1001 003122 Molla filarello</p>	 <p>ER110CD19650 0211 009650</p>	
 <p>ER110CD11801 0211 000801</p>	 <p>ER110CD11152 0211 001152</p>	 <p>ER110CD11484 0211 000484</p>	 <p>ER110CD10217 0211 050217</p>	 <p>ER110CD11420 0211 000420</p>	
 <p>ER110CD11459 0211 000459</p>	 <p>ER110CD22239 0212 000239</p>	 <p>ER110CD11217 0211 000217</p>	 <p>ER110CD14381 0244 000381</p>	 <p>ER110CD11201 0211 000201</p>	 <p>ER110CD22196 0212 000196 Salvadito</p>
 <p>ER110CD19836 0219 000836</p>	 <p>ER110CD19193 0219 000193</p>	 <p>ER110CD19185 0219 000185</p>	 <p>ER110CD11401 0211 000401/0271 000102 Tendifilo completo</p> <p>ER110CD14487 0211 004487 Bussola</p>		
 <p>ER110CD24779 0212 004779 Barra ago</p>			 <p>ER110CD25421 0212 005421</p>	 <p>ER106CD000090 0212 004931 CT</p>	 <p>ER106CD000092 0212 005058 CT</p>
 <p>ER110CD11511 0211 000551</p>			 <p>ER110CD11422 0211 000422</p>		

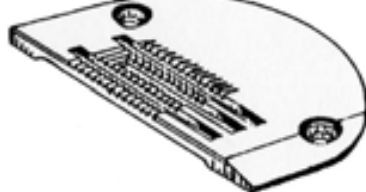



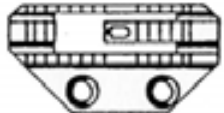
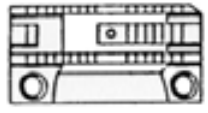





**Cl. 211**

 <p><b>ER110CD24897</b> 0212 004897</p>	 <p><b>ER110CD23473</b> 0223 000473</p>	 <p><b>ER110CD23459</b> 0223 000459</p>
--	--	--



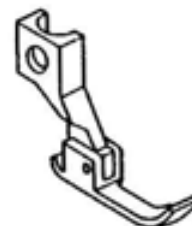
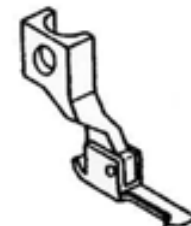













**Cl. 212**

 <p><b>ER110C000238</b> 0212 001211</p>		 <p><b>ER110C000241</b> 0212 010998</p>		 <p><b>ER110C000243</b> 0211 083284</p>		
 <p><b>ER110C000239</b> 0212 001212</p>	 <p><b>ER110C000240</b> 0212 001213</p>	 <p><b>ER110C000242</b> 0212 050102</p>	 <p><b>ER110C000244</b> 0212 083288</p>			
 <p><b>ER110C000235</b> 0212 010855</p>		 <p><b>ER110C000233</b> 0211 001641</p>		 <p><b>ER110C000245</b> 0211 082532</p>		
 <p><b>ER110C000236</b> 0212 010857</p>	 <p><b>ER110C000237</b> 0212 010856</p>	 <p><b>ER110C000234</b> 0212 001642</p>		 <p><b>ER110C000246</b> 0212 082533</p>		
	<p style="text-align: center;">Destro</p> <p><b>ER111CD2D032</b>     1/32" = 0,8</p> <p><b>ER111CD2D016</b>     1/16" = 1,6</p> <p><b>ER111CD2D008</b>     1/8" = 3,2</p> <p><b>ER111CD2D316</b>     3/16" = 4,8</p> <p><b>ER111CD2D004</b>     .1/4" = 6,4</p>		<p style="text-align: center;">Sinistro</p> <p><b>ER111CD2S032</b>     1/32" = 0,8</p> <p><b>ER111CD2S016</b>     1/16" = 1,6</p> <p><b>ER111CD2S008</b>     1/8" = 3,2</p> <p><b>ER111CD2S316</b>     3/16" = 4,8</p> <p><b>ER111CD2S004</b>     .1/4" = 6,4</p>		<p style="text-align: center;">Doppio</p> <p><b>ER111CD2DOPP</b></p>	

Cl. 212

 <b>ER111CD22903</b> 0212 002903	 <b>ER111CD21193</b> 0212 001193	 <b>ER111CD21643</b> 0212 001643 Largo	 <b>ER111CD22013</b> 0212 002013 Stretto	 <b>ER111CD2CC54</b> Piedino cerniera mm.5,4	 <b>ER111CD2CC70</b> Piedino cerniera mm. 7
 <b>ER111CD2CD54</b> Piedino cern. dx 5,4 <b>ER111CD2CD70</b> Piedino cern. Dx 7,0	 <b>ER111CD2CS54</b> Piedino cern. sx 5,4 <b>ER111CD2CS70</b> Piedino cern. Sx 7,0	 <b>ER111CD2CREG</b> Piedino cerniera regolabile	 <b>ER111CD200TE</b> Piedino teflon	 <b>ER111CD200TB</b> Ciabatta di ricambio	





Cl. 237, 238, 349, 380

 <b>ER110CD39415</b> 0249 000415	 <b>ER110CD49061</b> 0249 000061	 <b>ER110CD31402</b> 0238 001402	 <b>ER106C000086</b> 0204 001065		
 <b>ER106C000082</b> 0204 001077	 <b>ER106C000084</b> 0238 001418 HSS	 <b>ER106C000065</b> 0238 001417 HSS	 <b>ER110CD37293</b> 0380 007293	 <b>ER106C000064</b> 0238 006549	 <b>ER106CD76157</b> 0272 076157
 <b>ER106CD00683</b> 0227 000683	 <b>ER106CD00682</b> 0227 000682	 <b>ER106CD02075</b> 0697 002075	 <b>ER106CD16496</b> 0238 016496	 <b>ER106CD07042</b> 0272 007042	 <b>ER106CD07045</b> 0272 007045



Cl. 244, 245, 246, 247, 291, 292, 745

Cl. 265



 <p>ER106CD00079 0244 014161</p>	 <p>ER106CD00081 0244 014157</p>	 <p>ER106CD00063 0291 003002</p>	 <p>ER106CD00078 0265 008772</p>	 <p>ER106CD00077 0265 012265</p>
--	---	---	---	---

Cl. 265

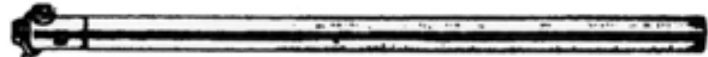
 <p>ER104C000032 0265 000951 HDU-265</p>	 <p>ER104C000295 0265 000965</p>	 <p>ER104C000031 0265 000771 ZZ mm. 10 Big HDU-M265</p>	 <p>ER104C000296 0265 0000776</p>	 <p>ER104C000354 0265 000789 ferro ER104C000355 0265 000789A Allum.</p>
---	---	--	--	--



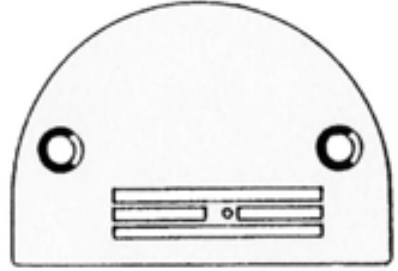
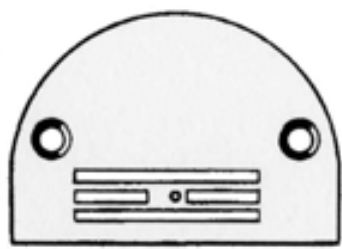
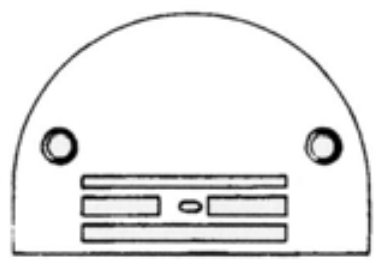
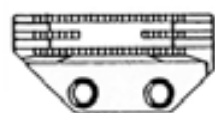
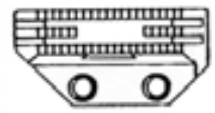
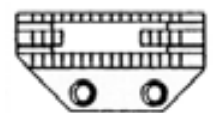



 <p>ER110CD65770 0265 000077</p>	 <p>ER110CD65165 0265 000165</p>
---	--







Cl. 271

 <p>ER110CD16504 0271 006504 Leggero</p>	 <p>ER110C000223 0211 004521 Medio</p>	 <p>ER110C000225 0211 001491 Pesante</p>
 <p>ER110CD16601 0271 006601 Leggero</p>	 <p>ER110CD16602 0271 006602 Medio</p>	 <p>ER110CD16603 0271 006603 Pesante</p>
 <p>ER110CD11339 0211 000339 Barra ago</p>	 <p>ER110CD11437      ER110CD72192 0211 000437      0272 000192 Barra piedino</p>	







Cl. 271

 <p><b>ER104C000037</b> 0271 000751 HDU-271 cl. 271</p>	 <p><b>ER104C000038</b> 0272 001121 HDU-272 cl. 272</p>	 <p><b>ER104C000219</b> 0211 001115</p>	 <p><b>ER104C000352</b> 0204 000230 ferro <b>ER104C000353</b> 0204 000230A <i>Allum</i></p>
--	--	---	--

 <p><b>ER110CD10215</b> 0211 050215</p>	 <p><b>ER110CD71197</b> 0271 000197</p>	 <p><b>ER110CD71193</b> 0271 000193</p>	 <p><b>ER110CD10214</b> 0211 050214</p>	 <p><b>ER110CD71199</b> 0271 000199</p>	 <p><b>ER110CD71202</b> 0271 000202</p>	 <p><b>ER110CD71206</b> 0271 000206</p>
--	--	--	--	---	--	--

 <p><b>ER110CD71207</b> 0271 000207</p>	 <p><b>ER110CD71204</b> 0271 000204</p>	 <p><b>ER110CD71205</b> 0271 000205</p>	 <p><b>ER110CD71208</b> 0271 000208</p>	 <p><b>ER110CD16497</b> 0216 000497</p>	 <p><b>ER110CD71192</b> 0271 000192</p>	 <p><b>ER110CD71501</b> 0271 001501</p>
---	---	---	---	---	---	---







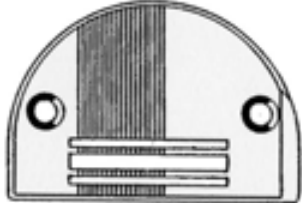
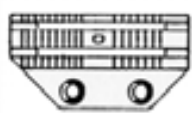
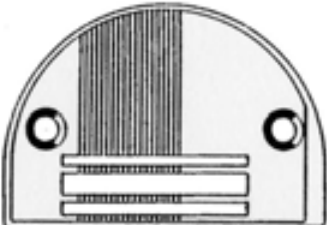
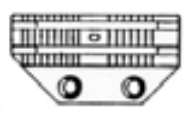

 <p><b>ER110CD11355</b> 0211 000355</p>	 <p><b>ER110CD71491</b> 0271 000491</p>	 <p><b>ER106C000093</b> 0271 001483</p>	 <p><b>ER106C000094</b> 0271 001497</p>
---	--	---	--

 <p><b>ER110CD11401</b> 0271 000102</p>	 <p><b>ER110CD71212</b> 0271 000212</p>	 <p><b>ER110CD71222</b> 0271 000222</p>	 <p><b>ER110CD71217</b> 0271 000217</p>	 <p><b>ER110CD16591</b> 0216 000591</p>	 <p><b>ER110CD71273</b> 0271 000273</p>	 <p><b>ER110CD13122</b> 1001 003122</p>
---	--	--	--	---	--	--

Cl. 272

 <p><b>ER110CD26501</b> 0272 006501</p>	 <p><b>ER110CD26601</b> 0272 006601</p>	 <p><b>ER110CD26502</b> 0272 006502</p>	 <p><b>ER110CD26602</b> 0272 006602</p>
--	--	---	--

**Cl. 272**





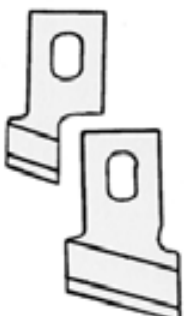
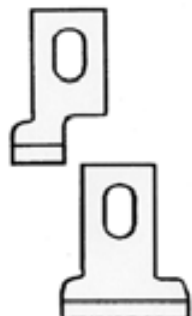









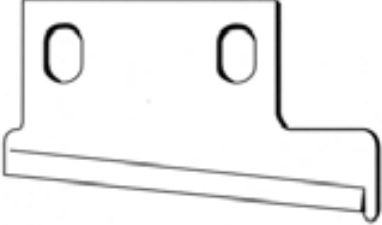

						
<b>ER111CD76801</b> 0272 006801 Normale	<b>ER111CD76807</b> 0272 006807 Largo	<b>ER111CD700TE</b> Piedino teflon	<b>ER111CD700TB</b> Ciabatta di ricambio	<b>ER111CD7CREG</b> Piedino cerniera regolabile		
						
<b>ER111CD7CD54</b> Cerniera dx mm.5,4 <b>ER111CD7CD70</b> Cerniera dx mm. 7	<b>ER111CD7CS54</b> Cerniera sx mm.5,4 <b>ER111CD7CS70</b> Cerniera sx mm. 7	<b>ER111CD7CC54</b> Piedino cerniera mm.5,4 <b>ER111CD7CC70</b> Piedino cerniera mm. 7				
	Destro		Sinistro		Doppio	
	<b>ER111CP1132</b>	1/32"=0,8	<b>ER111CP1132</b>	1/32"=0,8	<b>ER111CP1132</b>	1/32"=0,8
	<b>ER111CP1116</b>	1/16"=1,6	<b>ER111CP1116</b>	1/16"=1,6	<b>ER111CP1116</b>	1/16"=1,6
	<b>ER111CP1018</b>	1/8"=3,2	<b>ER111CP1018</b>	1/8"=3,2		
	<b>ER111CP1316</b>	3/16"=4,8	<b>ER111CP1316</b>	3/16"=4,8		
	<b>ER111CP1014</b>	1/4"=6,4	<b>ER111CP1014</b>	1/4"=6,4		
	<b>ER111CP1072</b>	mm. 7,2				
	<b>ER111CP1080</b>	mm. 8,0				
	<b>ER111CP1090</b>	mm. 9,0				
	<b>ER111CP1100</b>	mm. 10,0				
	<b>ER111CP1127</b>	mm. 12,7				
	<b>ER111CP1140</b>	mm. 14,0				
	<b>ER111CP1160</b>	mm. 16,0				
<b>ER111CP1180</b>	mm. 18,0					

**Cl. 551, 555, 556, 576, 577**









	COLTELLI NORMALI				COLTELLI TAGLIO PIATTO		
	Codice	mm.	Inch		Codice	mm.	Inch
<b>ER106C000522</b>	6,4	.1/4"	<b>ER106C000560</b>	6,4	.1/4"		
<b>ER106C000523</b>	9,5	3/8	<b>ER106C000561</b>	9,5	3/8		
<b>ER106C000524</b>	11,0	7/16	<b>ER106C000562</b>	11,0	7/16		
<b>ER106C000525</b>	12,5	.1/2	<b>ER106C000563</b>	12,5	.1/2		
<b>ER106C000526</b>	14,3	9/16	<b>ER106C000564</b>	14,3	9/16		
<b>ER106C000527</b>	16,0	5/8	<b>ER106C000565</b>	16,0	5/8		
<b>ER106C000528</b>	17,5	11/16	<b>ER106C000566</b>	17,5	11/16		
<b>ER106C000529</b>	19,0	.3/4	<b>ER106C000567</b>	19,0	.3/4		
<b>ER106C000530</b>	22,2	7/8	<b>ER106C000568</b>	22,2	7/8		
<b>ER106C000531</b>	25,4	1	<b>ER106C000569</b>	25,4	1		
<b>ER106C000532</b>	27,0	1.1/16	<b>ER106C000570</b>	27,0	1.1/16		
<b>ER106C000533</b>	28,5	1.1/8	<b>ER106C000571</b>	28,5	1.1/8		
<b>ER106C000534</b>	32,0	1.1/4	<b>ER106C000572</b>	32,0	1.1/4		







Cl. 551, 555, 556, 576, 577

						
ER110C000232 0555 000815	ER110CD51688 0556 001688	ER110CD51689 0556 001689	ER110CD51684 0556 001684	ER110CD51216 0556 001216	ER110CD52065 0556 002065 A	ER106CD13536 0556 013536
						
ER106CD12783 0556 012783	ER106CD12772 0556 012772		ER106CD50230 0577 350230	ER106CD50240 0577 350240	ER110CD50250 0577 350250	ER110CD50080 0577 350080
						
ER104C000025 0556 005001 HDU-556	ER104C000297 0556 005044	ER104C000407 0555 000919 ferro iron ER104C000408 0555 000919A Aluminium		ER110CD00555 Molla tendifilo		

Cl. 557, 558, 578, 579

			
ER104C000500 0557 002872	ER104C000504 0557 002872A	ER104C000505 0557 003243	ER104C000501 0557 000602A
			
ER104C000502 0557 000611	ER104C000503 0557 002876K	ER104C000507 0557 002035	ER104C000508 0557 003398









Cl. 557, 558, 578, 579

 <p><b>ER110CD00593</b> 0557 000593</p>	 <p><b>ER110CD8307A</b> 0558 000307 A</p>		 <p><b>ER110CD80274</b> 0558 000274 0557 000535</p>		
 <p><b>ER110CD86197</b> 0558 006197</p>	 <p><b>ER106C000073</b> 0557 001672</p>	 <p><b>ER106C000074</b> 0557 001674</p>	 <p><b>ER106C000075</b> 0557 001675</p>	 <p><b>ER106C000076</b> 0557 001677</p>	 <p><b>ER106CD01041</b> 0557 001041</p>
 <p><b>ER106CD01671</b> 0557 001671</p>	 <p><b>ER106CD02561</b> 0558 002561 <b>ER106CD02562</b> 0558 002562</p>	 <p><b>ER106CD02564</b> 0558 002564 <b>ER106CD02567</b> 0558 002567</p>	 <p><b>ER106C000070</b> 0557 001686 MS mm. 32 <b>ER106C000072</b> 0557 001684 MS mm. 25 <b>ER106C000071</b> 0557 001683 MS mm. 22</p>	 <p><b>ER106CD02405</b> 0558 002405 mm. 16 <b>ER106CD02406</b> 0558 002406 mm. 18 <b>ER106CD02408</b> 0558 002408 mm. 22 <b>ER106CD02410</b> 0558 002410 mm. 26</p>	
 <p><b>ER110CD86110</b> 0558 006110</p>	 <p><b>ER110CD86109</b> 0558 006109</p>	 <p><b>ER106CD08817</b> 0558 008817</p>	 <p><b>ER106CD08816</b> 0558 008816</p>	 <p><b>ER106CD08859</b> 0558 008859</p>	
 <p><b>ER106CD08858</b> 0558 008858</p>	 <p><b>ER106CD08869</b> 0558 008869</p>	 <p><b>ER106CD08868</b> 0558 008868</p>	 <p><b>ER106CD08879</b> 0558 008879</p>	 <p><b>ER106CD08878</b> 0558 008878</p>	

Cl. 570, 579

 <p><b>ER104C000161</b> 0570 001242 SH-570</p>	 <p><b>ER104C000405</b> 0570 001015 ferro</p> <p><b>ER104C000406</b> 0570 001015A Allum.</p>	 <p><b>ER110CD50933</b> 0570 000933</p>	 <p><b>ER110CD50727</b> 0570 000727</p>
 <p><b>ER110CD50974</b> 0570 000974</p>	 <p><b>ER106C000067</b> 0570 000961</p>	 <p><b>ER106C000069</b> 0570 000962</p>	 <p><b>ER106C000066</b> 0560 000453</p>
 <p><b>ER106CD92917</b> 0570 092917 A</p>	 <p><b>ER106CD92908</b> 0570 092908 A</p>	 <p><b>ER110CD92921</b> 0570 092921</p>	 <p><b>ER110CD92925</b> 0570 092925</p>

Cl. 745, 746, 748, 749

 <p><b>ER106CD60689</b> <b>ER106CD60690</b> 0746 060689 0746 060690</p>	 <p><b>ER106CD60691</b> <b>ER106CD60692</b> 0746 060691 0746 060692</p>	 <p><b>ER106CD0995A</b> <b>ER106CD09950</b> 0746 000995A 0746 000995</p>	 <p><b>ER106CD0996A</b> <b>ER106CD09960</b> 0746 000996A 0746 000996</p>	 <p><b>ER106CD0997A</b> <b>ER106CD09970</b> 0746 000997A 0746 000997</p>
 <p><b>ER106CD02553</b> 0246 002553</p>	 <p><b>ER106CD02706</b> 0246 002706</p>	 <p><b>ER106CD00419</b> 0748 000419</p>	<p>Данная информация для Вас предоставлена ООО "ШВЕЙПРОМКОМПЛЕКТ" т/ф (499) 2592598 г.Москва www.shveiprom.com 2592598@mail.ru</p>	

VITI PER DURKOPP

 <b>ER110CD11387</b> 0211 000387 Vite ago 211, 212,271,272	 <b>ER110CD11393</b> 0211 000393 Vite tensione cl. 211, 212	 <b>ER110CD11420</b> 0211 000420	 <b>ER110CD16131</b> 0216 000131 Vite griffa 211, 212,271,272	 <b>ER110CD16134</b> 0216 000134 Vite placca 211, 212,271,272
 <b>ER110CD16406</b> 0216 000406 Vite piedino 211,212	 <b>ER110CD16497</b> 0216 000497	 <b>ER110CD16573</b> 0216 000573 Vite piedino 271,272	 <b>ER110CD16609</b> 0216 000609 Vite tensione 211, 212	 <b>ER110CD11157</b> 0216 001157 Vite per guide
 <b>ER110CD23648</b> 0223 000648	 <b>ER110CD23734</b> 0223 000734	 <b>ER110CD49061</b> 0249 000061 Vite piedino 238	 <b>ER110CD65040</b> 0556 005040 Vite crochet 211, 212, 556	

Данная информация для  
 Вас предоставлена  
 ООО "ШВЕЙПРОМКОМПЛЕКТ"  
 т/ф (499) 2592598 г.Москва  
[www.shveiprom.com](http://www.shveiprom.com)  
[2592598@mail.ru](mailto:2592598@mail.ru)